

DESIGNED FOR ACCURACY. BUILT FOR TRUST

VS1000 – PRELIMINARY DATASHEET

Single axis analog accelerometer

A new reference for low to medium frequency MEMS sensing

The new Colibrys VS1000 offers the best performance stability with repetitive high-shocks resistance, as well as the lowest non-linearity and noise in the marketplace. Each product is fully tested and qualified to the highest Colibrys standards. It embeds a self-test function for your confidence at all time.



Functional Block Diagram

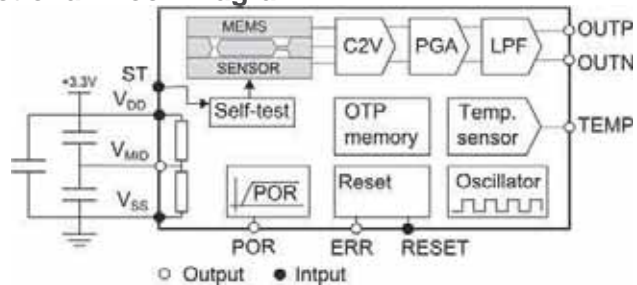

Key features

Parameter, typical values	VS1002	VS1005	VS1010	VS1030	VS1050	VS1100	VS1200	Unit
Full-scale acceleration	± 2	± 5	± 10	± 30	± 50	± 100	± 200	g
Frequency range (±5 %)	0-700	0-1'150	0-2'000	0-2300	0-2700	0-2'900	0-2'500	Hz
Frequency range (±3dB)	0-1'150	0-1'900	0-3'200	0-4'000	0-4'500	0-5'000	0-7'000	Hz
Non-linearity (full scale)	0.1	0.1	0.1	0.1	0.1	0.1	0.1	%
Noise (in band)	7	17	34	102	170	339	678	µg/√Hz
Scale factor (nominal)	1'350	540	270	90	54	27	13.5	mV/g
Scale factor temperature coefficient	120	120	120	120	120	120	120	ppm/°C
Bias temperature coefficient (max)	±0.2	±0.5	±1	±3	±5	±10	±20	mg/°C
Shock Survivability	6'000	6'000	6'000	6'000	6'000	6'000	6'000	g

Featured Applications (non-exhaustive)

Seismic – Class C 90dB

Automated earthquake building damage assessment system
Early earthquake warning system
Seismic intensity instrumentation
Structural Health Monitoring (SHM)

Monitoring & Control

Data loggers
Drilling (equipment stability)
Elevator (lift)
Telemetry
Vibration monitoring (overload, vibration and shock)
Wind turbine (monitor the gearbox and equipment)

Test & Measurement

Aero flight testing
Aircraft carrier landing drop testing
Automotive testing (ride quality / durability, vehicle dynamics, ride & NVH, head rest vibration)
Down borehole testing
Flutter testing
Robotic (factory automation)
Structure health testing (building, bridge, dam, nuclear plant, pipeline inspection, PIGS)
Pre-flight wind tunnel testing

Railway technology

Active suspension
Active tilting
Bogie monitoring
Preventive maintenance
Height control of magneto-levitation
High-speed train and Maglev innovation technology
Rolling stock fatigue analysis
Track monitoring system
Track slope and geometry measurement system
Vibration monitoring system

Specifications

VS1002.A

All values are specified at ambient temperature (20°C) and at 3.3 V supply voltage V_{DD} , unless otherwise stated. Acceleration values are defined for differential signal (OUTP-OUTN).

Parameter	Comments	Min	Typ.	Max	Unit
Accelerometer					
Full scale		±2			g
Non linearity	% of full scale, under vibrations		0.1	0.3	%
Frequency response	±5%	250	700		Hz
Frequency response	±3dB		1150		Hz
Noise	in band		7		µg/√Hz
Resonance frequency			1.2		kHz
Bias					
Calibration		-7		7	mg
Temperature coefficient	Measured at 3 temperatures [1]	-0.2		0.2	mg/°C
Scale factor					
Calibration		1330	1350	1370	mV/g
Temperature coefficient	Measured at 3 temperatures [1]	20	120	220	ppm/°C
Axis misalignment					
Nominal		-10		10	mrad
Self-test					
Frequency	Square wave output	22	24.4	26.8	Hz
Duty cycle			50		%
Amplitude	peak to peak		1.0		g
Input threshold voltage	active high	80			% V_{DD}
Temperature sensor					
Output voltage @20°C		1.20	1.23	1.26	V
Sensitivity			-4.0		mV/°C
Output current load				10	µA
Output capacitive load				10	pF
Reset					
Input threshold voltage	active low			20	% V_{DD}
Power supply (V_{DD})					
Input voltage		3.2	3.3	3.4	V
Operating current consumption			3	4	mA
Startup time	Sensor operational, delay once POR triggered		40		µs
Accelerometer outputs					
Output voltages	OutP, OutN over full scale	0.14		3.16	V
Differential output	Over full scale		±2.7		V
Resistive load		1000			kΩ
Capacitive load				100	pF

[1] The bias and scale factor temperature coefficients have been measured at 3 temperatures points [-40°C, +20°C, +85°C] but is operational from -55°C to +125°C.

Table 1: VS1002 Specifications

VS1005.A

All values are specified at ambient temperature (20°C) and at 3.3 V supply voltage V_{DD} , unless otherwise stated. Acceleration values are defined for differential signal (OUTP-OUTN).

Parameter	Comments	Min	Typ.	Max	Unit
Accelerometer					
Full scale		±5			g
Non linearity	% of full scale, under vibrations		0.1	0.3	%
Frequency response	±5%	700	1150		Hz
Frequency response	±3dB		1900		Hz
Noise	in band		17		µg/√Hz
Resonance frequency			1.9		kHz
Bias					
Calibration		-17		17	mg
Temperature coefficient	Measured at 3 temperatures [1]	-0.5		0.5	mg/°C
Scale factor					
Calibration		532	540	548	mV/g
Temperature coefficient	Measured at 3 temperatures [1]	20	120	220	ppm/°C
Axis misalignment					
Nominal		-10		10	mrad
Self-test					
Frequency	Square wave output	22	24.4	26.8	Hz
Duty cycle			50		%
Amplitude	peak to peak		1.0		g
Input threshold voltage	active high	80			% V_{DD}
Temperature sensor					
Output voltage @20°C		1.20	1.23	1.26	V
Sensitivity			-4.0		mV/°C
Output current load				10	µA
Output capacitive load				10	pF
Reset					
Input threshold voltage	active low			20	% V_{DD}
Power supply (V_{DD})					
Input voltage		3.2	3.3	3.4	V
Operating current consumption			3	4	mA
Startup time	Sensor operational, delay once POR triggered		40		µs
Accelerometer outputs					
Output voltages	OutP, OutN over full scale	0.14		3.16	V
Differential output	Over full scale		±2.7		V
Resistive load		1000			kΩ
Capacitive load				100	pF

[1] The bias and scale factor temperature coefficients have been measured at 3 temperatures points [-40°C, +20°C, +85°C] but is operational from -55°C to +125°C.

Table 2: VS1005 Specifications

VS1010.A

All values are specified at ambient temperature (20°C) and at 3.3 V supply voltage V_{DD} , unless otherwise stated. Acceleration values are defined for differential signal (OUTP-OUTN).

Parameter	Comments	Min	Typ.	Max	Unit
Accelerometer					
Full scale		±10			g
Non linearity	% of full scale, under vibrations		0.1	0.3	%
Frequency response	±5%	1000	2000		Hz
Frequency response	±3dB		3200		Hz
Noise	in band		34		µg/√Hz
Resonance frequency			3.2		kHz
Bias					
Calibration		-33		33	mg
Temperature coefficient	Measured at 3 temperatures [1]	-1		1	mg/°C
Scale factor					
Calibration		266	270	274	mV/g
Temperature coefficient	Measured at 3 temperatures [1]	20	120	220	ppm/°C
Axis misalignment					
Nominal		-10		10	mrad
Self-test					
Frequency	Square wave output	22	24.4	26.8	Hz
Duty cycle			50		%
Amplitude	peak to peak		1		g
Input threshold voltage	active high	80			% V_{DD}
Temperature sensor					
Output voltage @20°C		1.20	1.23	1.26	V
Sensitivity			-4.0		mV/°C
Output current load				10	µA
Output capacitive load				10	pF
Reset					
Input threshold voltage	active low			20	% V_{DD}
Power supply (V_{DD})					
Input voltage		3.2	3.3	3.4	V
Operating current consumption			3	4	mA
Startup time	Sensor operational, delay once POR triggered		40		µs
Accelerometer outputs					
Output voltages	OutP, OutN over full scale	0.14		3.16	V
Differential output	Over full scale		±2.7		V
Resistive load		1000			kΩ
Capacitive load				100	pF

[1] The bias and scale factor temperature coefficients have been measured at 3 temperatures points [-40°C, +20°C, +85°C] but is operational from -55°C to +125°C.

Table 3: VS1010 Specifications

VS1030.A

All values are specified at ambient temperature (20°C) and at 3.3 V supply voltage V_{DD} , unless otherwise stated. Acceleration values are defined for differential signal (OUTP-OUTN).

Parameter	Comments	Min	Typ.	Max	Unit
Accelerometer					
Full scale		±30			g
Non linearity	% of full scale, under vibrations		0.1	0.3	%
Frequency response	±5%	1500	2300		Hz
Frequency response	±3dB		4000		Hz
Noise	in band		102		μg/√Hz
Resonance frequency			5.2		kHz
Bias					
Calibration		-100		100	mg
Temperature coefficient	Measured at 3 temperatures [1]	-3		3	mg/°C
Scale factor					
Calibration		88.5	90	91.5	mV/g
Temperature coefficient	Measured at 3 temperatures [1]	20	120	220	ppm/°C
Axis misalignment					
Nominal		-10		10	mrad
Self-test					
Frequency	Square wave output	22	24.4	26.8	Hz
Duty cycle			50		%
Amplitude	peak to peak		1.0		g
Input threshold voltage	active high	80			% V_{DD}
Temperature sensor					
Output voltage @20°C		1.20	1.23	1.26	V
Sensitivity			-4.0		mV/°C
Output current load				10	μA
Output capacitive load				10	pF
Reset					
Input threshold voltage	active low			20	% V_{DD}
Power supply (V_{DD})					
Input voltage		3.2	3.3	3.4	V
Operating current consumption			3	4	mA
Startup time	Sensor operational, delay once POR triggered		40		μs
Accelerometer outputs					
Output voltages	OutP, OutN over full scale	0.15		3.15	V
Differential output	Over full scale		±2.7		V
Resistive load		1000			kΩ
Capacitive load				100	pF

[1] The bias and scale factor temperature coefficients have been measured at 3 temperatures points [-40°C, +20°C, +85°C] but is operational from -55°C to +125°C.

Table 4: VS1030 specifications

VS1050.A

All values are specified at ambient temperature (20°C) and at 3.3 V supply voltage V_{DD} , unless otherwise stated. Acceleration values are defined for differential signal (OUTP-OUTN).

Parameter	Comments	Min	Typ.	Max	Unit
Accelerometer					
Full scale		±50			g
Non linearity	% of full scale, under vibrations		0.1	0.3	%
Frequency response	±5%	1500	2700		Hz
Frequency response	±3dB		4500		Hz
Noise	in band		169		μg/√Hz
Resonance frequency			6.5		kHz
Bias					
Calibration		-167		167	mg
Temperature coefficient	Measured at 3 temperatures [1]	-5		5	mg/°C
Scale factor					
Calibration		53	54	55	mV/g
Temperature coefficient	Measured at 3 temperatures [1]	20	120	220	ppm/°C
Axis misalignment					
Nominal		-10		10	mrad
Self-test					
Frequency	Square wave output	22	24.4	26.8	Hz
Duty cycle			50		%
Amplitude	peak to peak		1.0		g
Input threshold voltage	active high	80			% V_{DD}
Temperature sensor					
Output voltage @20°C		1.20	1.23	1.26	V
Sensitivity			-4.0		mV/°C
Output current load				10	μA
Output capacitive load				10	pF
Reset					
Input threshold voltage	active low			20	% V_{DD}
Power supply (V_{DD})					
Input voltage		3.2	3.3	3.4	V
Operating current consumption			3	4	mA
Startup time	Sensor operational, delay once POR triggered		40		μs
Accelerometer outputs					
Output voltages	OutP, OutN over full scale	0.14		3.16	V
Differential output	Over full scale		±2.7		V
Resistive load		1000			kΩ
Capacitive load				100	pF

[1] The bias and scale factor temperature coefficients have been measured at 3 temperatures points [-40°C, +20°C, +85°C] but is operational from -55°C to +125°C.

Table 5: VS1050 Specifications

VS1100.A

All values are specified at ambient temperature (20°C) and at 3.3 V supply voltage V_{DD} , unless otherwise stated. Acceleration values are defined for differential signal (OUTP-OUTN)..

Parameter	Comments	Min	Typ.	Max	Unit
Accelerometer					
Full scale		±100			g
Non linearity	% of full scale, under vibrations		0.1	0.3	%
Frequency response	±5%	1500	2900		Hz
Frequency response	±3dB		5000		Hz
Noise	in band		339		µg/√Hz
Resonance frequency			8.5		kHz
Bias					
Calibration		-333		333	mg
Temperature coefficient	Measured at 3 temperatures [1]	-10		10	mg/°C
Scale factor					
Calibration		26	27	28	mV/g
Temperature coefficient	Measured at 3 temperatures [1]	20	120	220	ppm/°C
Axis misalignment					
Nominal		-10		10	mrad
Self-test					
Frequency	Square wave output	22	24.4	26.8	Hz
Duty cycle			50		%
Amplitude	peak to peak		1.0		g
Input threshold voltage	active high	80			% V_{DD}
Temperature sensor					
Output voltage @20°C		1.20	1.23	1.26	V
Sensitivity			-4.0		mV/°C
Output current load				10	µA
Output capacitive load				10	pF
Reset					
Input threshold voltage	active low			20	% V_{DD}
Power supply (V_{DD})					
Input voltage		3.2	3.3	3.4	V
Operating current consumption			3	4	mA
Startup time	Sensor operational, delay once POR triggered		40		µs
Accelerometer outputs					
Output voltages	OutP, OutN over full scale	0.14		3.16	V
Differential output	Over full scale		±2.7		V
Resistive load		1000			kΩ
Capacitive load				100	pF

[1] The bias and scale factor temperature coefficients have been measured at 3 temperatures points [-40°C, +20°C, +85°C] but is operational from -55°C to +125°C.

Table 6: VS1100 Specifications

VS1200.A

All values are specified at ambient temperature (20°C) and at 3.3 V supply voltage V_{DD} , unless otherwise stated. Acceleration values are defined for differential signal (OUTP-OUTN) and are validated at maximum $\pm 100g$ range.

Parameter	Comments	Min	Typ.	Max	Unit
Accelerometer					
Full scale		± 200			g
Non linearity	% of full scale, under vibrations		0.1	0.3	%
Frequency response	$\pm 5\%$	1500	2500		Hz
Frequency response	$\pm 3dB$		7000		Hz
Noise	in band		678		$\mu g/\sqrt{Hz}$
Resonance frequency			11.8		kHz
Bias					
Calibration		-667		667	mg
Temperature coefficient	Measured at 3 temperatures [1]	-20		20	mg/°C
Scale factor					
Calibration		13.0	13.5	14.0	mV/g
Temperature coefficient	Measured at 3 temperatures [1]	20	120	220	ppm/°C
Axis misalignment					
Nominal		-10		10	mrad
Self-test					
Frequency	Square wave output	22	24.4	26.8	Hz
Duty cycle			50		%
Amplitude	peak to peak		1.0		g
Input threshold voltage	active high	80			% V_{DD}
Temperature sensor					
Output voltage @20°C		1.20	1.23	1.26	V
Sensitivity			-4.0		mV/°C
Output current load				10	μA
Output capacitive load				10	pF
Reset					
Input threshold voltage	active low			20	% V_{DD}
Power supply (V_{DD})					
Input voltage		3.2	3.3	3.4	V
Operating current consumption			3	4	mA
Startup time	Sensor operational, delay once POR triggered		40		μs
Accelerometer outputs					
Output voltages	OutP, OutN over full scale	0.10		3.20	V
Differential output	Over full scale		± 2.7		V
Resistive load		1000			k Ω
Capacitive load				100	pF

[1] The bias and scale factor temperature coefficients have been measured at 3 temperatures points [-40°C, +20°C, +85°C] but is operational from -55°C to +125°C.

Table 7: VS1200 Specifications

Absolute maximum ratings

Absolute maximum ratings are stress ratings. Stresses in excess of these ratings can cause permanent damage to the device. Exposure of the device to the absolute maximum ratings for an extended period may degrade the device and affect its reliability.

Parameter	Comments	Min	Typ	Max	Unit
Supply voltage V_{DD}		-0.3		3.9	V
Voltage at any PIN		-0.3		$V_{DD} + 0.3$	V
Operational temperature		-55		+125	°C
Multiple Shock	Functional operation after 500 shocks (0.2ms / half-sine / any axis)			1'500	g
Shock Survivability	Single shock (non-repetitive) 0.15ms half-sine, in one direction (HA, PA or IA axes)			6'000	g
ESD stress	HBM model	-1		1	kV

Table 8: Absolute maximum ratings

Typical performances characteristics

VS1002.A

3.3 VDC supply voltage (V_{DD}) and ambient temperature for all graphs, unless otherwise stated

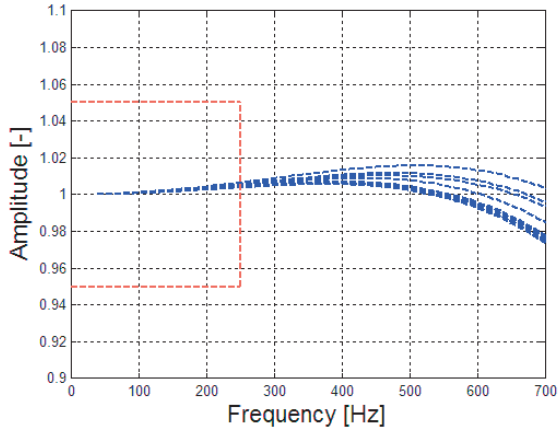

Figure 1: Typical frequency response in band

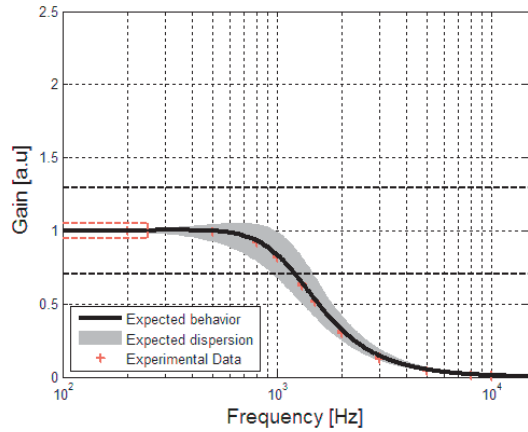

Figure 2: Typical high frequency response

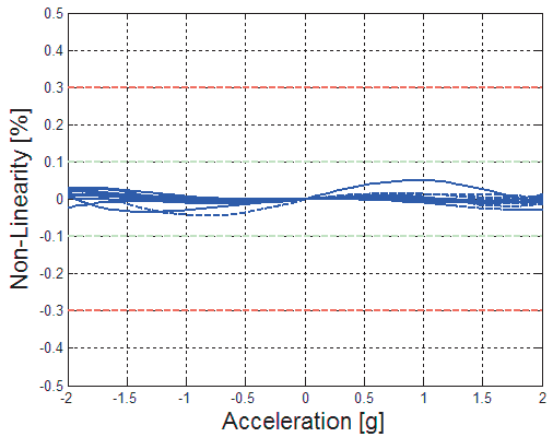

Figure 3 : Non linearity under vibration

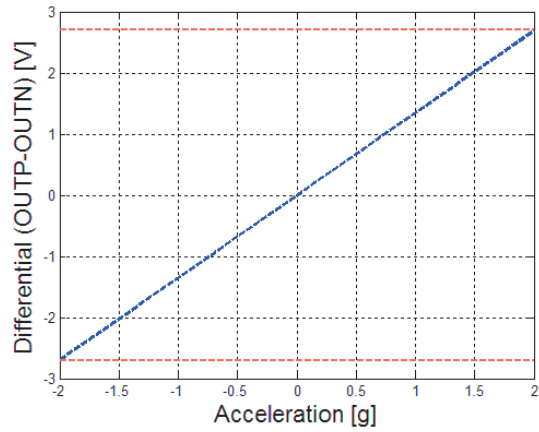

Figure 4: Differential acceleration output (OUTP-OUTN) at full scale

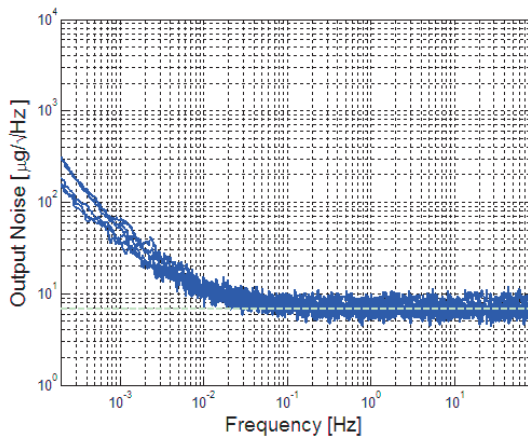

Figure 5: Typical Low Frequency Noise

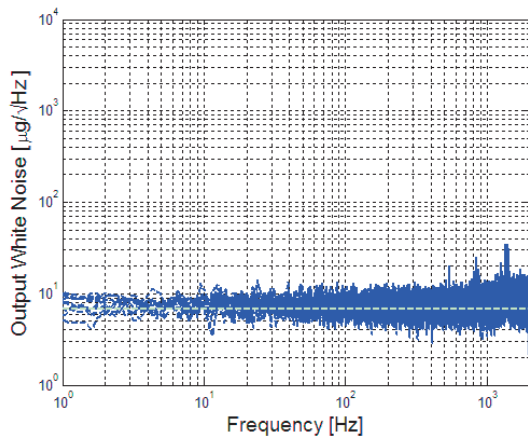

Figure 6: Typical white noise

VS1005.A

3.3 VDC supply voltage (V_{DD}) and ambient temperature for all graphs, unless otherwise stated

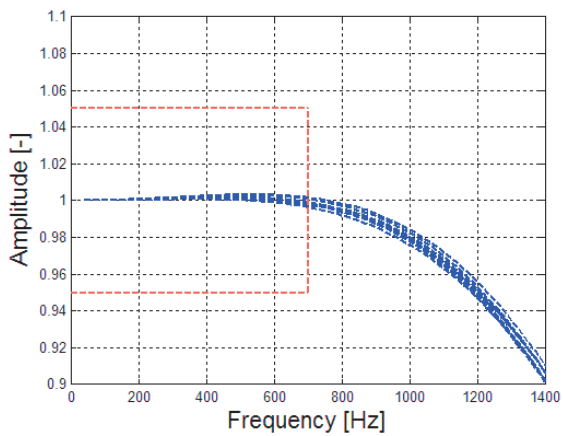

Figure 7: Typical frequency response in band

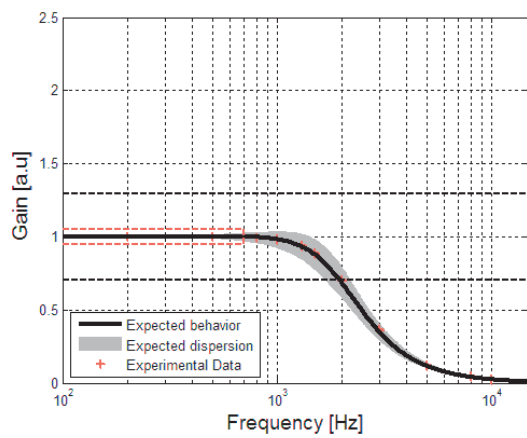

Figure 8: Typical high frequency response
Courtesy of Customer

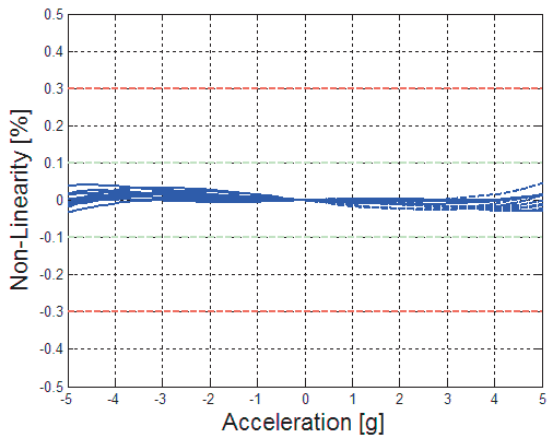

Figure 9 : Non linearity under vibration

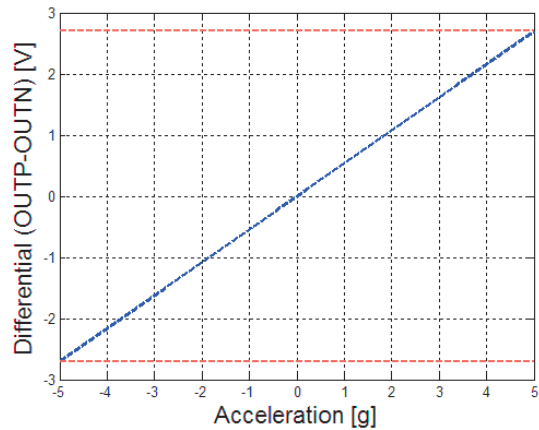

Figure 10: Differential acceleration output (OUTP-OUTN) at full scale

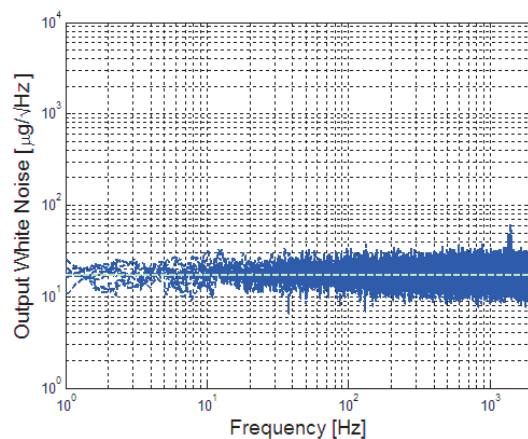

Figure 11: Typical white noise

VS1010.A

3.3 VDC supply voltage (V_{DD}) and ambient temperature for all graphs, unless otherwise stated

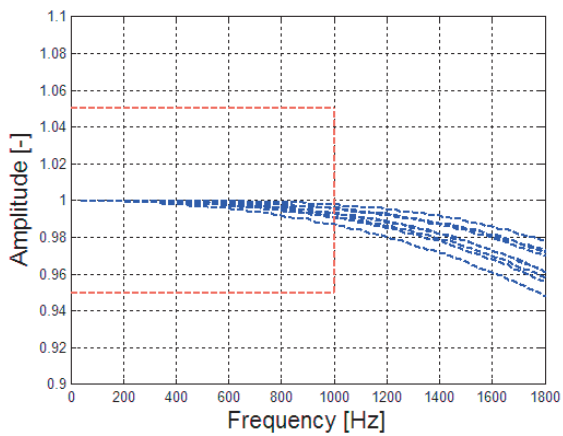

Figure 12: Typical frequency response in band

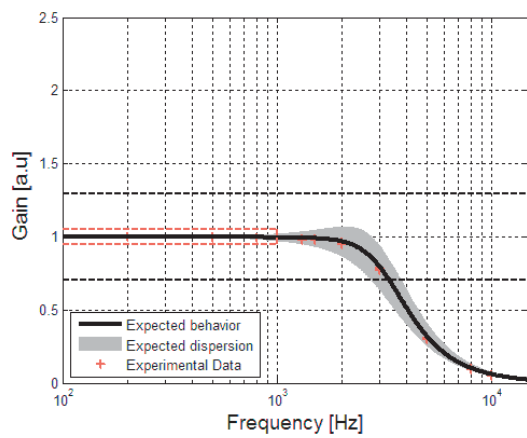

Figure 13: Typical high frequency response
Courtesy of Customer

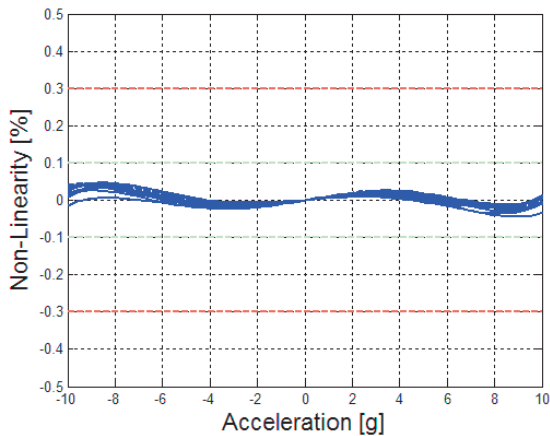

Figure 14 : Non linearity under vibration

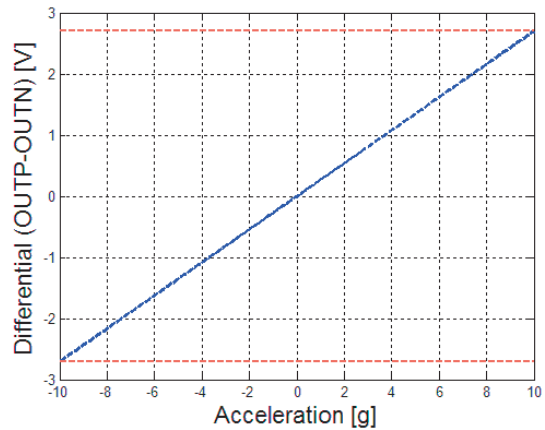

Figure 15: Differential acceleration output (OUTP-OUTN) at full scale

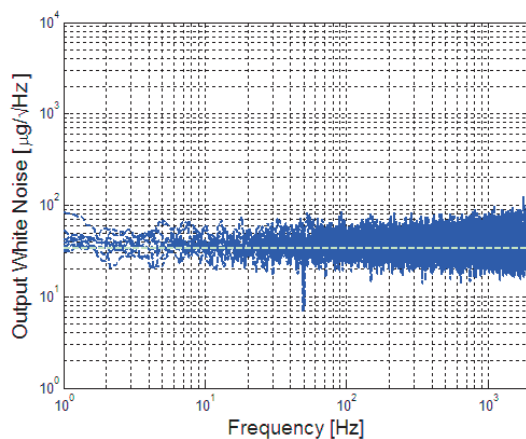

Figure 16: Typical white noise

VS1030.A

3.3 VDC supply voltage (V_{DD}) and ambient temperature for all graphs, unless otherwise stated

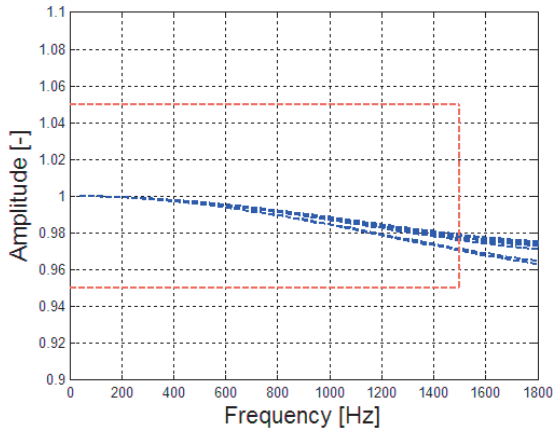

Figure 17: Typical frequency response in band

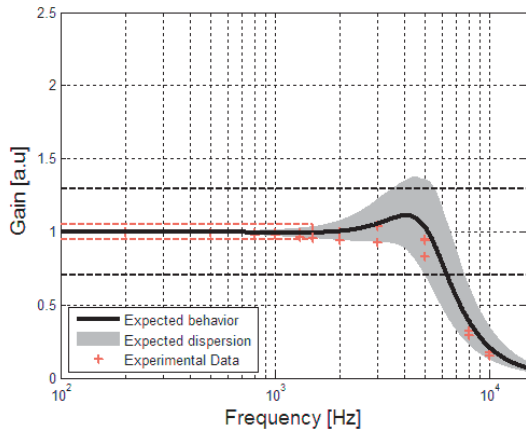

Figure 18: Typical high frequency response
Courtesy of Customer

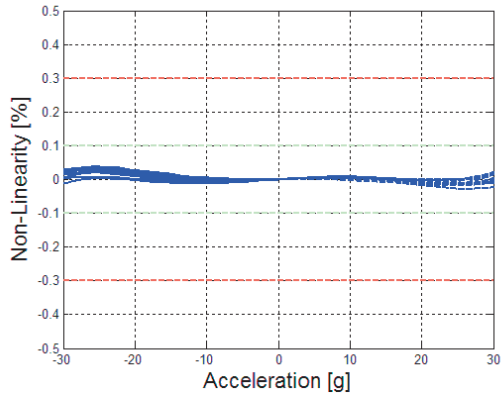

Figure 19 : Non linearity under vibration

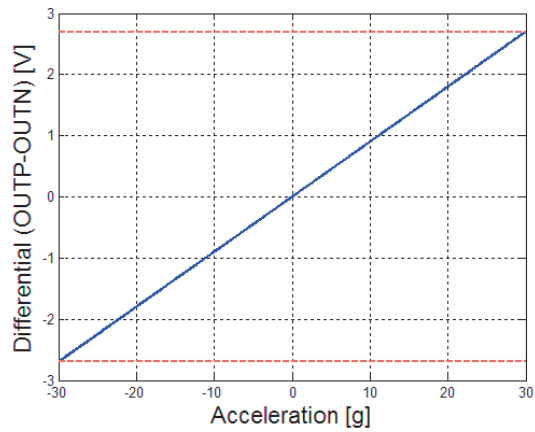

Figure 20: Differential acceleration output
(OUTP-OUTN) at full scale

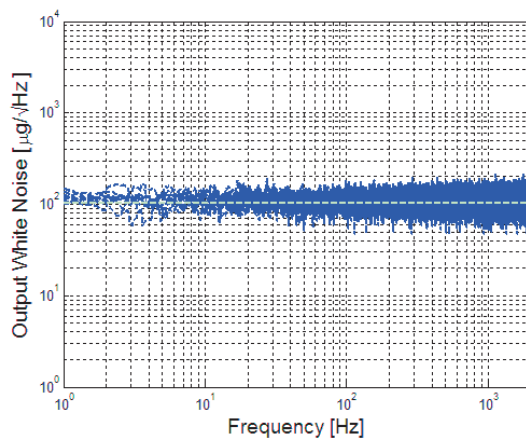

Figure 21: Typical white noise

VS1050.A

3.3 VDC supply voltage (V_{DD}) and ambient temperature for all graphs, unless otherwise stated

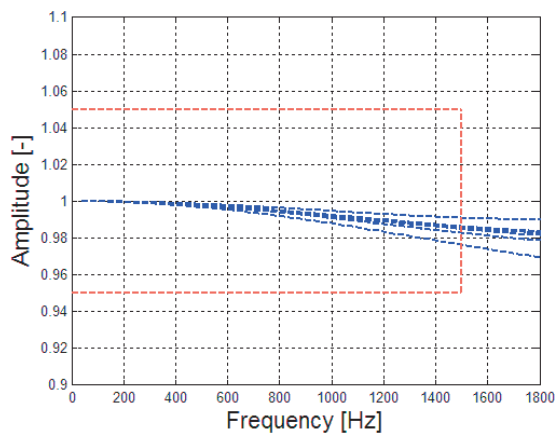

Figure 22: Typical frequency response in band

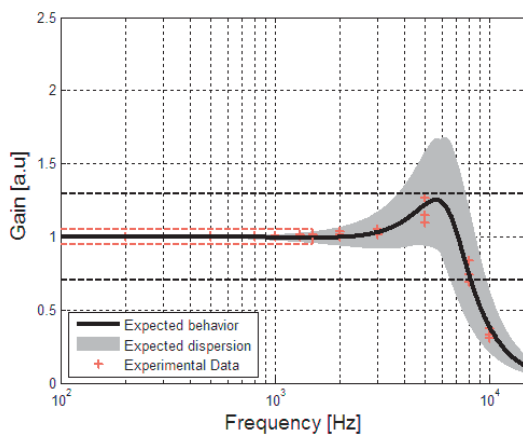

Figure 23: Typical high frequency response
Courtesy of Customer

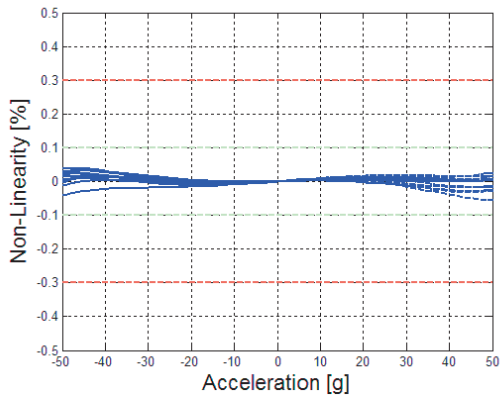

Figure 24 : Non linearity under vibration

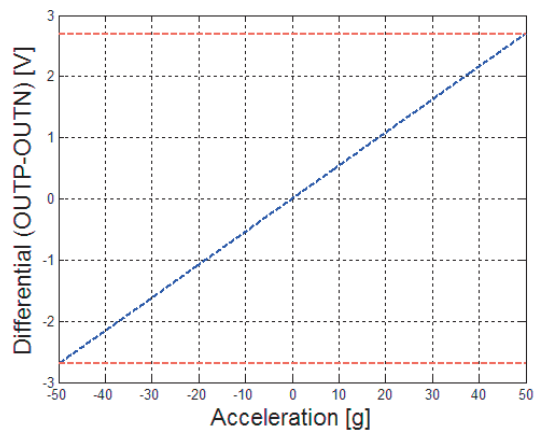

Figure 25: Differential acceleration output
(OUTP-OUTN) at full scale

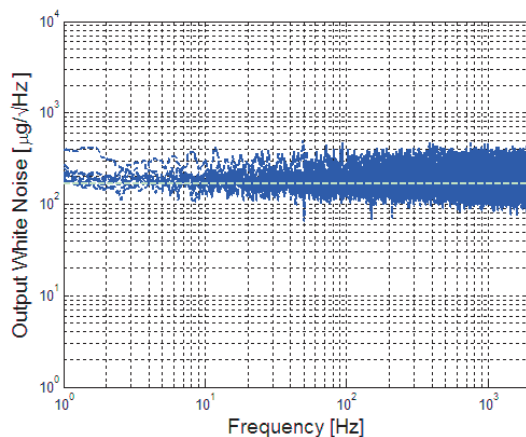

Figure 26: Typical white noise

VS1100.A

3.3 VDC supply voltage (V_{DD}) and ambient temperature for all graphs, unless otherwise stated

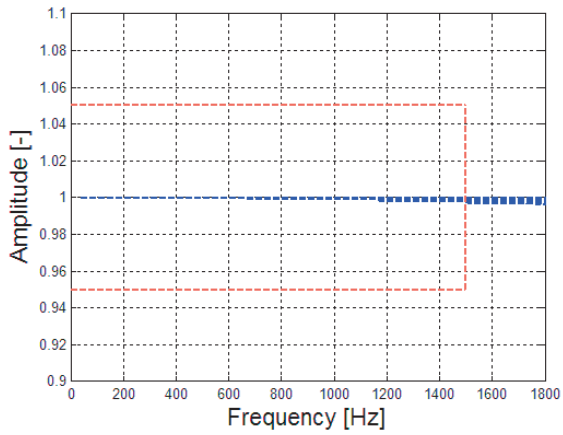

Figure 27: Typical frequency response in band

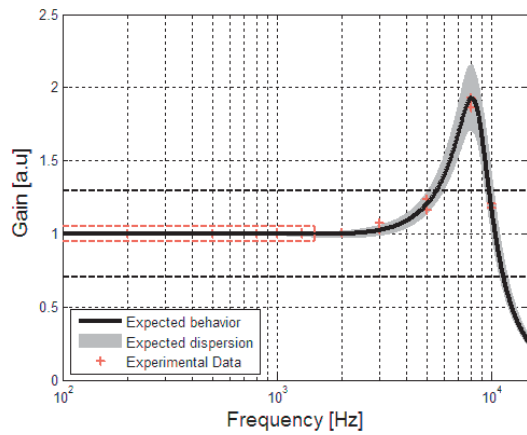

Figure 28: Typical high frequency response
Courtesy of Customer

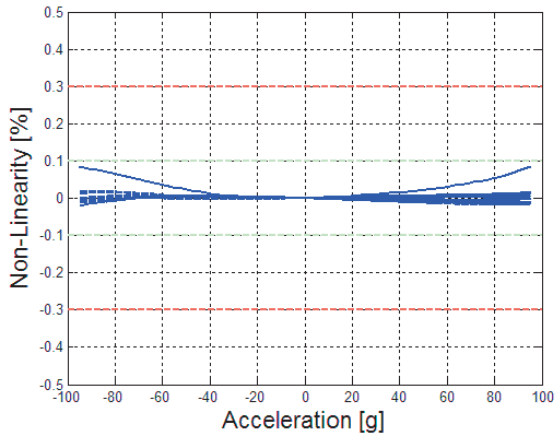

Figure 29 : Non linearity under vibration

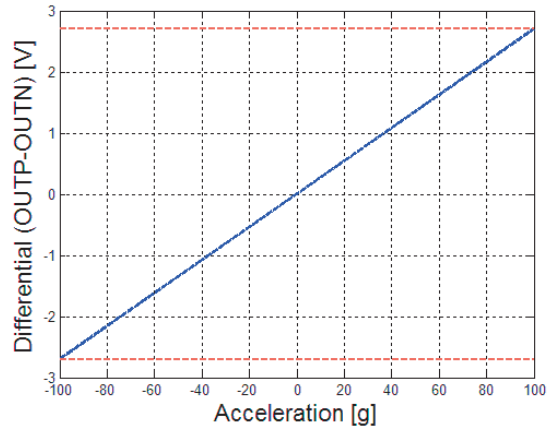

Figure 30: Differential acceleration output (OUTP-OUTN) at full scale

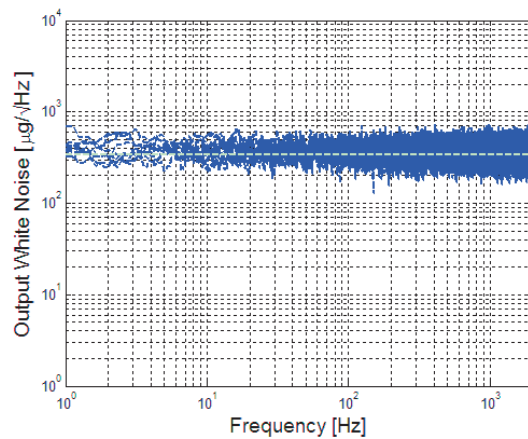

Figure 31: Typical white noise

VS1200.A

3.3 VDC supply voltage (V_{DD}) and ambient temperature for all graphs, unless otherwise stated

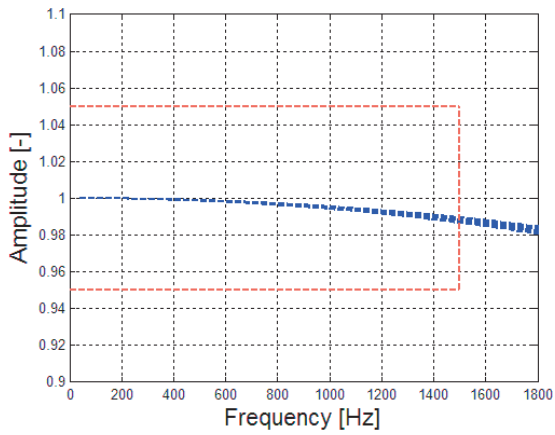

Figure 32: Typical frequency response in band

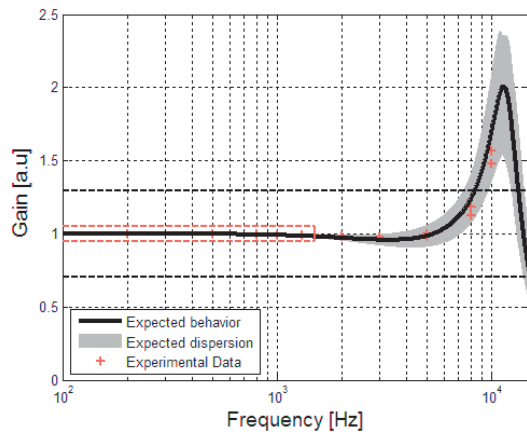

Figure 33: Typical high frequency response
Courtesy of Customer

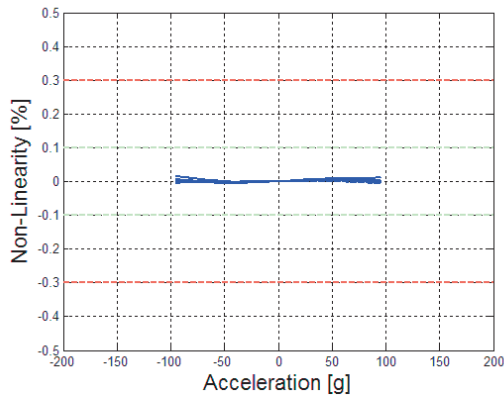

Figure 34 : Non linearity under vibration

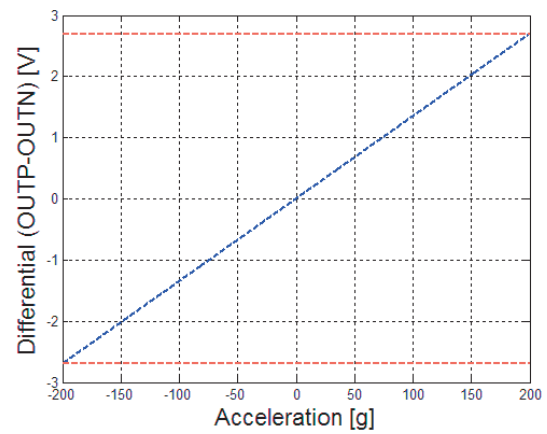

Figure 35: Differential acceleration output
(OUTP-OUTN) at half full scale

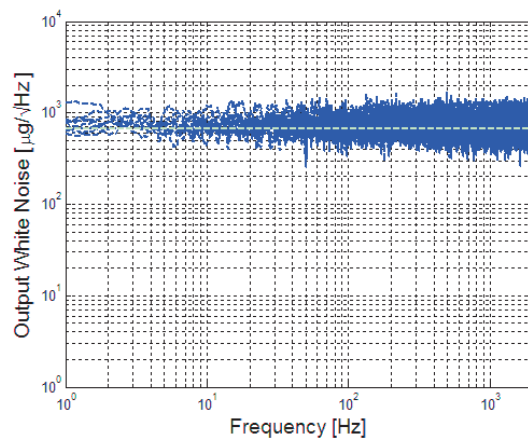

Figure 36: Typical white noise

Pinout description

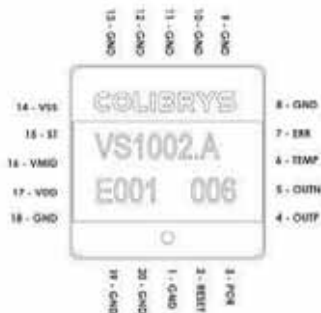

Figure 37: Pinout top view

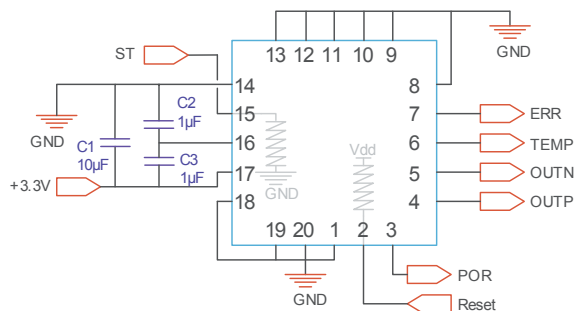

Figure 38: Proximity circuit & pull-up/down

The device pin layout is given in Figure 37Error! Reference source not found. and a description of each pin given in the Figure 38Error! Reference source not found.. The capacitors C1 (10 µF), C2 (1 µF) and C3 (1 µF) are shown in Error! Reference source not found. and must be placed as close as possible to the VS1000 package and are used as decoupling capacitors and for a proper sensor startup. COG or X7R capacitors @ 5 % are recommended.

Pin Nb.	Pin name	Type	Description
2	RESET	DI, PU	System reset signal, active low
3	POR	DO	Power On Reset
4	OUTP	AO	Differential output positive signal
5	OUTN	AO	Differential output negative signal
6	TEMP	AO	Temperature analogue output
7	ERR	DO	Error signal (flag)
14	VSS (0 V)	PWR	Connect to ground plane
15	ST	DI, PD	Self-test activation, active high
16	VMID	AO	Internal ASIC reference voltage. For decoupling capacitors only
17	VDD (3.3 V)	PWR	Analogue power supply
1,8,9,10,11, 12,13,18,19,20	GND	GND	Must be connected to ground plane (GND)

PWR, power / AO, analog output / AI, analog input / DO, digital output / DI, digital input / PD, internal pull down / PU, internal pull up

Table 9: VS1000 pinout description

Electrical Functions description

POR (Power-On-Reset) function

The POR block continuously monitors the power supply during startup as well as normal operation. It ensures a proper startup of the sensor and acts as a brownout protection in case of a drop in supply voltage.

During sensor power on, the POR signal stays low until the supply voltage reaches the POR threshold voltage (V_{TH}) and begins the startup sequence (see Figure 39 **Error! Reference source not found.**). In case of a supply voltage drop, the POR signal will stay low until the supply voltage exceeds V_{TH} and is followed by a new startup sequence. The ERR signal is high (equal to V_{DD}) until the startup sequence is complete.

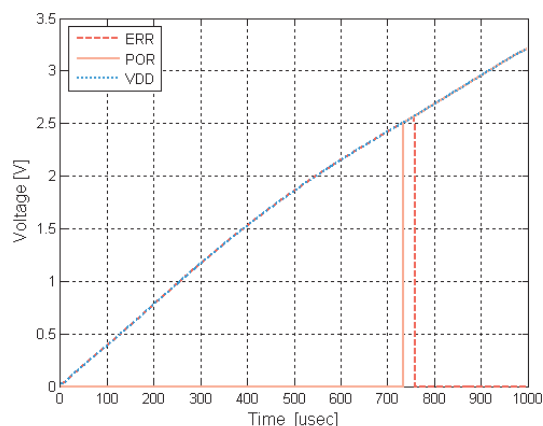

Figure 39: Typical sensor power sequence using the recommended circuit

External Reset

An external reset can be activated by the user through the RESET input pin. During a reset phase, the accelerometer outputs (OUTP & OUTN) are forced to $V_{DD} / 2$ and the error signal (ERR) is activated (high), see Figure 40 **Error! Reference source not found.**

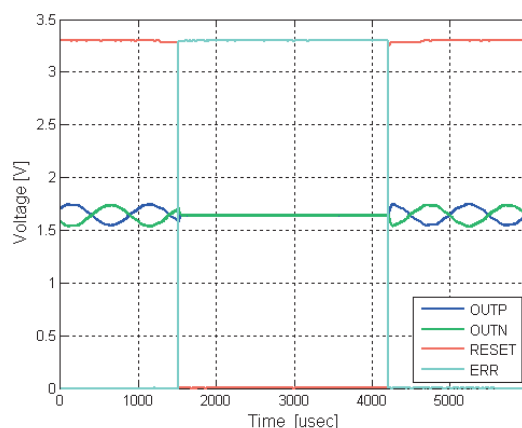

Figure 40: Typical sensor reset sequence with external reset

Built-in self-Test function

The built-in Self-Test mode generates a square wave signal on the device outputs (OUTP & OUTN) and can be used for device failure detection (see Figure 41 **Error! Reference source not found.**).

When activated, it induces an alternating electrostatic force on the mechanical sensing element and emulates an input acceleration at a defined frequency. This electrostatic force is in addition to any inertial acceleration acting on the sensor during self-test; therefore it is recommended to use the self-test function under quiescent conditions.

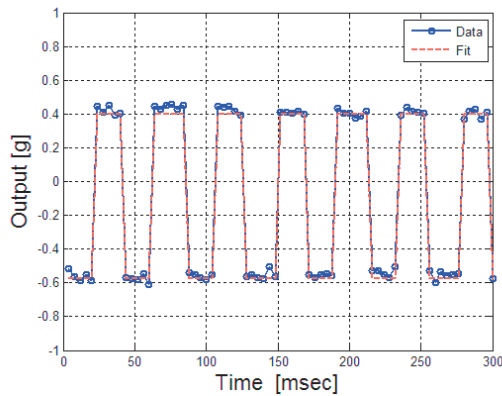

Figure 41: Built-in Self-test signal on the differential acceleration output (frequency: 24 Hz / amplitude 1g)

Overload and error function

The device continuously monitors the validity of the accelerometer output signals. If an error occurs, the ERR pin goes high and informs the user that the output signals are not valid. An error can be raised in the following cases:

- Out of tolerance power supply (POR low), such as during power on
- During external reset phase (user activation of the reset)
- Temperature overload (if temperature is higher than the specification)
- Under high acceleration overload (e.g. high shock)

Upon a high-amplitude shock, the internal overload circuit resets the electronics and initiates a new startup of the readout electronics. This sequence is repeated until the acceleration input signal returns to normal operation range. This behavior is illustrated on the figure below with a large shock of amplitude 1'500 g: the overload protection is active during the shock and the sensor is fully operational once the acceleration is within the operating range

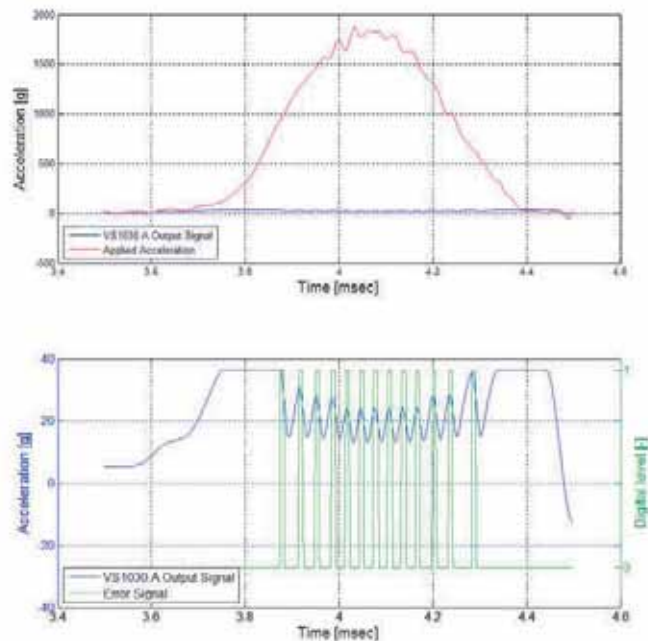

Figure 42: Accelerometer submitted to a 1'500 g / 0.5 ms shock. The overload protection is active during the shock and the sensor is fully operational once the acceleration is within the operating range.

Dimensions and package specifications

The outline of the LCC20 ceramic package and the Center of Gravity (●) is illustrated in the drawing below. Error! Reference source not found..

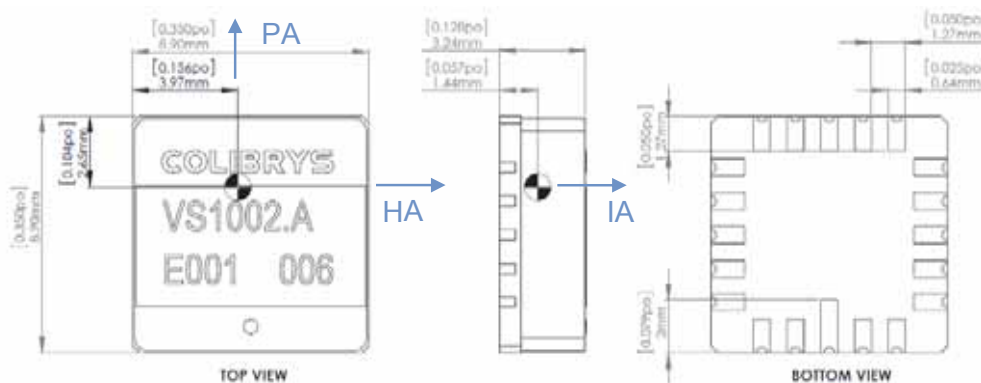

Figure 43: Package mechanical dimension

Parameter	Comments	Min	Typ	Max	Unit
Lead finishing	Au plating	0.5		1.5	μm
	Ni plating	1.27	4	8.89	μm
	W (tungsten)	10		15	μm
Hermeticity	According to MIL-STD-833-G			5-10-8	atm·cm ³ /s
Weight				1.5	grams
Size	X		8.9	9.2	mm
	Y		8.9	9.2	mm
	Z		3.23	3.5	mm
Packaging	RoHS compliant part. Nonmagnetic, LCC, 20 pin housing.				
Proximity effect	The sensor is sensitive to external parasitic capacitance. Moving metallic objects with large mass or parasitic effect in close proximity of the accelerometer (mm range) must be avoided to insure best product performances. A ground plane below the accelerometer is recommended as a shielding.				
Reference plane for axis alignment	LCC must be tightly fixed to the PCB, using the bottom of the housing as the reference plane for axis alignment. Using the lid as reference plane or for assembly may affect specifications and product reliability (i.e. axis alignment and/or lid soldering integrity)				

Table 10: Package specifications

Recommended circuit

In order to obtain the best device performance, particular attention must be paid to the proximity analog electronics. A proposed circuit that includes a reference voltage, the sensor decoupling capacitors and output buffers is described in Figure 44. **Error! Reference source not found..**

Optimal acceleration measurements are obtained using the differential output ($OUTP_B - OUTN_B$). If a single-ended acceleration signal is required, it must be generated from the differential acceleration output in order to remove the common mode noise.

Block Diagram & Schematic

The main blocks that require particular attention are the power supply management, the accelerometer sensor electronic and the output buffer. The following schematic shows an example of VS1000 implementation.

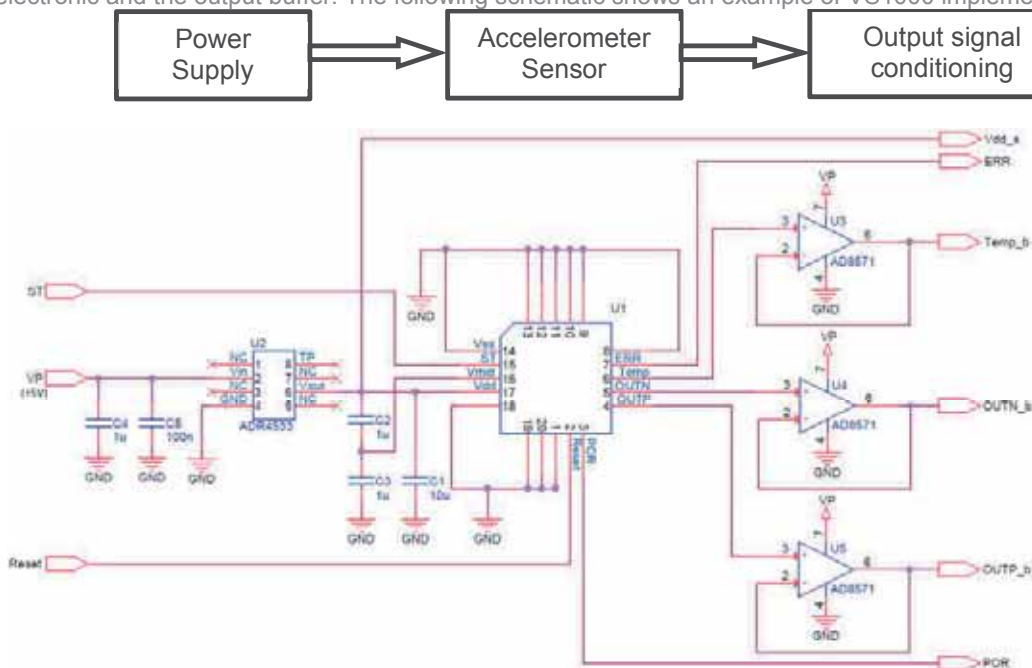

Figure 44: Recommended Block diagram & Schematic

Power Supply

The accelerometer output is ratiometric to the power supply voltage and its performance will directly impact the accelerometer bias, scale factor, noise or thermal performance. Therefore, a low-noise, high-stability and low-thermal drift power supply is recommended. Key performance should be:

- Output noise $< 1\mu V/\sqrt{Hz}$
- Output temperature coefficient $< 10ppm/^\circ C$

The power supply can be used as an output signal (V_{DD_S}) in order to compensate any variation on the power supply voltage that will impact the accelerometer signal (ratiometric output).

The electronic circuit within the accelerometer is based on a switched-capacitor architecture clocked @ 200 KHz. High-frequency noise or spikes on the power supply will affect the outputs and induce a signal within the device bandwidth.

Accelerometer sensor

The sensor block is composed of the VS1000 accelerometer and the 3 decoupling capacitors: C1, C2 and C3. These capacitors are mandatory for the proper operation and full performance of the accelerometer. We recommend placing them as close as possible to the VS1000 package on the printed circuit board.

Output signal conditioning

The output buffer must be correctly selected in order match the VS1000 output impedance and signal bandwidth. The AD8571 is proposed for the acceleration output ($OUTP$ & $OUTN$) and the temperature output ($TEMP$).

A technical note related to single ended output is available on Colibrys website.

SMD recommendation

A recommended land pattern for LCC20 is shown in the Figure 45. It should be tested and qualified in the manufacturing process. The land pattern and pad sizes have a pitch of 1.27mm and the pin 1 is longer to insure the right orientation of the product during mounting. After assembly, the orientation can be controlled from the top with an extra point printed on the lid which correspond to pin 1.

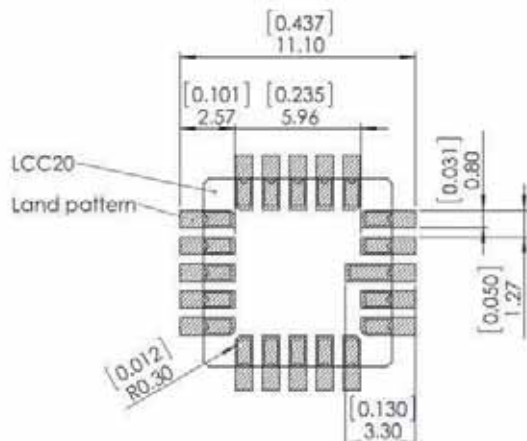

Figure 45 : LCC20 land pattern recommendation (unit are mm/[inch])

The VS1000 is suitable for Sn/Pb and Pb-Free soldering and ROHs compliant. Typical temperature profiles recommended by the solder manufacturer can be used with a maximum ramp-up of 3°C/second and a maximum ramp-down of 6°C/second: The exact profile depends on the used solder paste.

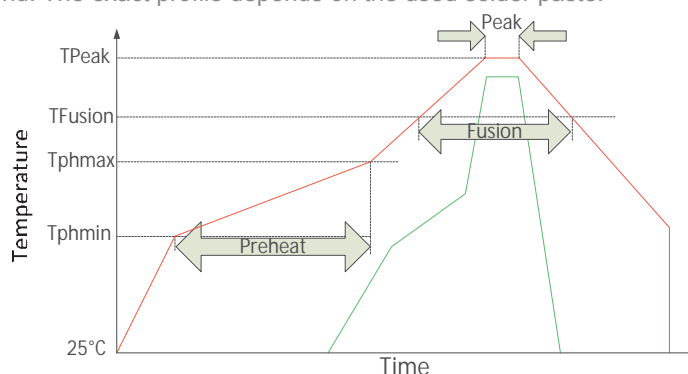

Figure 46: Soldering Temperature Profile

Phase	Sn/Pb		Pb-Free	
	Duration [sec]	Temperature [°C]	Duration [sec]	Temperature [°C]
Peak	10-30	235-240	20-40	245-250
Fusion	60-150	183	60-150	217
Preheat	60-120	Min : 100 Max : 150	60-180	Min : 150 Max : 200

Table 11: Soldering temperatures & times

The cleaning process of electronic boards sometimes involves ultrasounds. This is strongly prohibited on our sensors. Ultrasonic cleaning will have a negative impact on silicon elements which generally causes damages.



Note: Ultrasonic cleaning is forbidden in order to avoid damage of the MEMS accelerometer

Handling precautions

The VS1000 is packaged in a hermetic ceramic housing to protect the sensor from the ambient environment. However, poor handling of the product can induce damage to the hermetic seal or to the ceramic package made of brittle material (alumina). It can also induce internal damage to the MEMS accelerometer that may not be visible and cause electrical failure or reliability issues. Handle the component with caution: shocks, such as dropping the accelerometer on hard surface, may damage the product.

The component is susceptible to damage due to electrostatic discharge (ESD). Therefore, suitable precautions shall be employed during all phases of manufacturing, testing, packaging, shipment and handling. Accelerometer will be supplied in antistatic bag with ESD warning label and they should be left in this packaging until use. The following guidelines are recommended:

- Always manipulate the devices in an ESD-controlled environment
- Always store the devices in a shielded environment that protects against ESD damage (at minimum an ESD-safe tray and an antistatic bag)
- Always wear a wrist strap when handling the devices and use ESD-safe gloves



This product can be damaged by electrostatic discharge (ESD). Handle with appropriate precautions.

Product identification markings

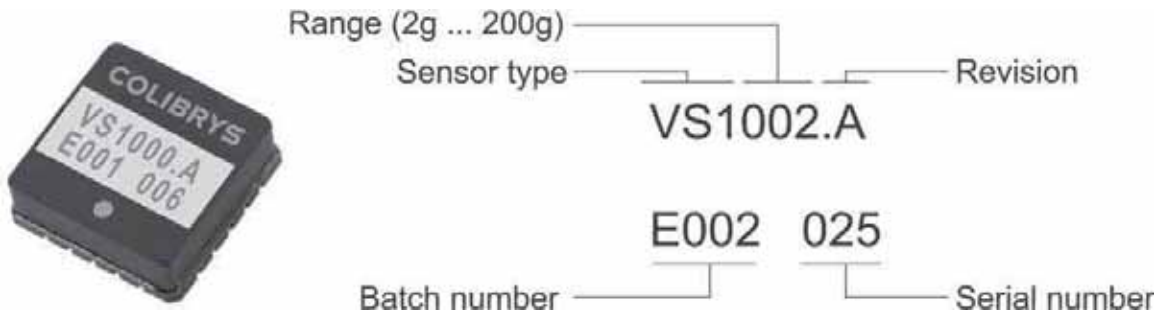

Ordering Information

Description	Product	Measurement range	Colibrys reference number
Single analogue axis MEMS accelerometer, 	VS1002.A	±2g	37618071
	VS1005.A	±5g	37613081
	VS1010.A	±10g	37615033
	VS1030.A	±30g	37618084
	VS1050.A	±50g	37619043
	VS1100.A	±100g	37619061
	VS1200.A	±200g	37619081

Glossary of parameters of the Data Sheet

g [m/s²]

Unit of acceleration, equal to standard value of the earth gravity (Accelerometer specifications and data supplied by Colibrys use 9.80665 m/s²).

Bias [mg]

The accelerometer output at zero g.

Bias temperature coefficient [mg/°C]

Variation of the bias under variable external temperature conditions (slope of the best fit straight line through the curve of bias vs. temperature).

Scale factor [mV/g]

The ratio of the change in output (in volts) to a unit change of the input (in units of acceleration); thus given in mV/g.

Scale factor temperature coefficient [ppm/°C]

Maximum deviation of the scale factor under variable external temperature conditions.

Temperature sensitivity

Sensitivity of a given performance characteristic (typically scale factor, bias, or axis misalignment) to operating temperature, specified generally at 20°C. Expressed as the change of the characteristic per degree of temperature change; a signed quantity, typically in ppm/°C for scale factor and mg/°C for bias. This figure is useful for predicting maximum scale factor error with temperature, as a variable when modelling is not accomplished.

Non-linearity [% FS]

The maximum deviation of accelerometer output from the best linear fit over the full scale input acceleration. The deviation is expressed as a percentage of the full-scale output (+A_{FS}).

Frequency response [Hz]

Frequency range from DC to the specified value where the variation in the frequency response amplitude is less than -3 dB (or -5 % for vibration sensors).

Resonance frequency [kHz]

Typical resonance frequency of the mounted device.

Noise [µg/√Hz]

Undesired perturbations in the accelerometer output signal, which are generally uncorrelated with desired or anticipated input accelerations.

Axes definition

Input Axis (IA): sensitive axis

Pendulous Axis (PA): Aligned with the proof mass beam and perpendicular to the input axis

Hinge Axis (HA): Perpendicular to the input and pendulous axes

Quality

Colibrys is ISO 9001:2008, ISO 14001:2004 and OHSAS 18001:2007 certified

Colibrys is in compliant with the European Community Regulation on chemicals and their safe use (EC 1907/2006) REACH.

VS1000 products comply with the EU-RoHS directive 2011/65/EC (Restrictions on hazardous substances) regulations

Recycling : please use appropriate recycling process for electrical and electronic components (DEEE)

VS1000 products are compliant with the Swiss LSPro : 930.11 dedicated to the security of products

Note:

- *VS1000 accelerometers are available for sales to professional only*
- *Les accéléromètres VS1000 ne sont disponibles à la vente que pour des clients professionnels*
- *Die Produkte der Serie VS1000 sind nur im Vertrieb für kommerzielle Kunden verfügbar*
- *Gli accelerometri VS1000 sono disponibili alla vendita soltanto per clienti professionisti*

Colibrys complies with due diligence requirements of Section 1502, Conflict Minerals, of the US Dodd-Frank Wall Street Reform and Consumer Protection Act and follows latest standard EICC/GeSI templates for Conflict Material declaration

